

GS 04L42B01-01E

OVERVIEW

The DX2000 is a DAQSTATION that displays real-time measured data on a color LCD and saves data on a CompactFlash memory card (CF card). It can be hooked up to network via Ethernet, which enables to inform by E-mail and to monitor on Web site as well as to transfer files by using FTP. Also, it can communicate with Modbus/RTU or Modbus/TCP.

It comes with a four, eight, ten, twenty, thirty, forty-channel or forty eight-channel model. As the input signal, a DC voltage, thermocouple, resistance temperature detector, or contact signal can be set to each channel. The data saved on a CF card can be converted by data conversion software to Lotus 1-2-3, Excel, or ASCII format file, facilitating processing on a PC. Not only this, the Viewer software allows a PC to display waveforms on its screen and to print out waveforms.



STANDARD SPECIFICATIONS

General Specifications

Construction

- Mounting: Flush panel mounting (on a vertical plane)
Mounting may be inclined downward up to 30 degrees from a horizontal plane.
- Allowable panel thickness: 2 to 26 mm
- Material: Case: drawn steel
Bezel: polycarbonate
Display filter: polycarbonate
- Case color: Case: Grayish blue green (Munsell 2.0B 5.0/1.7 or equivalent)
Bezel: Charcoal grey light (Munsell 10B 3.6/0.3 or equivalent)
- Front panel: Water and dust-proof (based on IEC529-IP65)
- Dimensions: 288(W) x 288(H) x 226(D)* mm
*Maximum
- Weight: DX2004, DX2010: approx. 6.0 kg*
DX2008, DX2020: approx. 6.3 kg*
DX2030 : approx. 6.9 kg*
DX2040, DX2048: approx. 7.3 kg*
*without optional features

Input

- Number of inputs: DX2004: four channels
DX2008: eight channels
DX2010: ten channels
DX2020: twenty channels
DX2030: thirty channels
DX2040: forty channels
DX2048: forty eight channels
- Measurement interval: DX2004, DX2008: 125 ms, 250 ms, 25 ms (fast sampling mode*)
DX2010, DX2020, DX2030, DX2040, DX2048: 1 s (Not available when A/D integration time is set to 100 ms), 2 s, 5 s, 125 ms (fast sampling mode*)
* A/D integration time is fixed to 1.67 ms in case of fast sampling mode.
- Inputs: DCV (DC voltage), TC (thermocouple), RTD (resistance temperature detector), DI (digital input for event recording), DCA (DC current with external shunt resistor attached)

Input type	Range	Measuring range	
DCV	20 mV	-20.000 to 20.000 mV	
	60 mV	-60.00 to 60.00 mV	
	200 mV	-200.00 to 200.00 mV	
	2 V	-2.0000 to 2.0000 V	
	6 V	-6.000 to 6.000 V	
	1-5V	-0.800 to 5.200 V	
	20 V	-20.000 to 20.000 V	
	50 V	-50.00 to 50.00 V	
TC	R ^{*1}	0.0 to 1760.0°C	32 to 3200°F
	S ^{*1}	0.0 to 1760.0°C	32 to 3200°F
	B ^{*1}	0.0 to 1820.0°C	32 to 3308°F
	K ^{*1}	-200.0 to 1370.0°C	-328 to 2498°F
	E ^{*1}	-200.0 to 800.0°C	-328.0 to 1472.0°F
	J ^{*1}	-200.0 to 1100.0°C	-328.0 to 2012.0°F
	T ^{*1}	-200.0 to 400.0°C	-328.0 to 752.0°F
	N ^{*1}	0.0 to 1300.0°C	32 to 2372°F
	W ^{*2}	0.0 to 2315.0°C	32 to 4199°F
	L ^{*3}	-200.0 to 900.0°C	-328.0 to 1652.0°F
	U ^{*3}	-200.0 to 400.0°C	-328.0 to 752.0°F
	WR ^{e*4}	0.0 to 2400.0°C	32 to 4352°F
RTD	Pt100 ^{*5}	-200.0 to 600.0°C	-328.0 to 1112.0°F
	JPt100 ^{*5}	-200.0 to 550.0°C	-328.0 to 1022.0°F
DI	DCV input (TTL)	OFF : less than 2.4 V ON : more than 2.4 V	
	Contact input	Contact ON/OFF	

*1 R, S, B, K, E, J, T, N: IEC584-1 (1995), DIN IEC584, JIS C 1602-1995
 *2 W: W-5% Rd/W-26% Rd (Hoskins Mfg. Co.), ASTM E988
 *3 L: Fe-CuNi, DIN43710, U: Cu-CuNi, DIN43710
 *4 WR^e: W-3%Re/W-25%Re (Hoskins Mfg. Co.)
 *5 Pt100: JIS C 1604-1997, IEC 751-1995, DIN IEC751-1996
 JPt100: JIS C 1604-1989, JIS C 1606-1989
 Measuring current: i = 1mA

A/D integration time:

20 ms (50 Hz), 16.7 ms (60 Hz), 100ms (50/60Hz for DX2010/2020/2030/2040/2048), or AUTO selectable (automatic selection by detection of power supply frequency)
 A/D integration time is fixed to 1.67 ms (600Hz) in case of fast sampling mode.

Thermocouple burnout:

Burnout upscale/downscale function can be switched on/off (for each channel).
 Burnout upscale/downscale selectable
 Normal: Less than 2 kΩ, Burn out: More than 100 kΩ
 Detection current: approx. 10 μ A

1-5V range burnout:

Burnout upscale/downscale function can be switched on/off (for each channel).
 Burnout upscale/downscale selectable
 Upscale burnout: More than +10% of configured span
 Downscale burnout: Less than -5% of configured span

Moving average:

Moving average on/off selectable for each channel
 Moving average cycles 2 to 400 selectable

Calculation:

Differential computation:
 Between any two channels
 Available for DCV, TC, RTD and DI ranges.

Linear scaling:

Available for DCV, TC, RTD and DI ranges.
 Scaling limits: -30000 to 30000
 Decimal point: user-selectable
 Engineering unit: user-definable, up to 6 characters
 Over value: Exceeds ± 5% of scaling limits (on/off selectable)

Square root:

Available for DCV range.
 Scaling limits: -30000 to 30000
 Decimal point: user-selectable
 Engineering unit : user-definable, up to 6 characters
 Low level cut off: 0.0 to 5.0% of display span
 Over value: Exceeds ± 5% of scaling limits (on/off selectable)

1-5VDC scaling:

Available for 1-5VDC range.
 Scaling limits: -30000 to 30000
 Display span limit: 0.800 to 5.200
 Decimal point: user-selectable
 Engineering unit : user-definable, up to 6 characters
 Low level cut off: Fixed to lower span limit
 Over value: Exceeds ± 5% of scaling limits (on/off selectable)

Display

Display unit:

10.4-inch TFT color LCD (VGA, 640 x 480 pixels)

Note) In the part of crystal display, there are some pixels that can't always turn on or off. Please understand that the brightness of screen looks uneven because of characteristics of crystal display, but it is not out of order.

Display group:

Each measurement channel and computation channel can be assigned to display group of the trend, digital and bargraph display.

Number of display: 36 groups
 Number of assignable channels for one group: 10 channels

Display color:

Trend/Bargraph:
 Selectable from 24 colors

Background:
 White or black selectable

Trend display:

Trend display type:
 Vertical, horizontal, landscape, horizontal split or circular selectable

Number of indication channels:
 10 channels per display (maximum)

Number of display:
 36 displays (36 groups)

Line width:
 1, 2, and 3 pixels selectable

Scales:
 Maximum 10 scales.
 Bargraph, green band area and alarm mark can be displayed on scale display.
 Number of divisions: Selectable from 4 to 12 or C10 (10 divisions by main scale mark and scale values are displayed on 0, 30, 50, 70 and 100% position).

- Waveform span rate:
15, 30 sec., 1, 2, 5, 10, 15, 20, 30 min., 1, 2, 4, 10 hours/div selectable
(15 sec/div is available for only DX2004 and DX2008)
- Circular waveform span rate:
20, 30 min., 1, 2, 6, 8, 12, 16 hours, 1, 2 days, 1, 2, 4 weeks/rev selectable
(20 min/rev is available for only DX2004 and DX2008)
- Bargraph display:
Direction: Vertical or horizontal selectable
Number of indication channels:
10 channels per display
Number of display:
36 displays (36 groups)
Scales: Green band area and alarm mark can be displayed on scale display.
Number of divisions: Selectable from 4 to 12
Reference position: Left, right or center
Display renewal rate: 1 s
- Digital indication:
Number of indication channels:
10 channels per display
Number of display:
36 displays (36 groups)
Display renewal rate: 1 s
- Overview display:
Number of indication channels:
Measuring values and alarm status of all channels
- Information display:
Alarm summary display:
Display the list of latest 1000 alarms summary.
Jump to historical trend display by cursor pointing.
Message summary display:
Display the list of latest 500 messages and time.
Jump to historical trend display by cursor pointing.
Memory information:
Display the file list in internal memory.
Jump to historical trend display by cursor pointing.
Report information:
Display the report data in internal memory.
Modbus status:
Display the Modbus status.
Relay status:
Display the on/off status of internal switch and relay output.
- Log display:
Log display types:
Login log, error log, communication log, FTP log, Web log, E-mail log, SNMP log, DHCP log, Modbus log
- Tags:
Number of characters:
16 characters maximum
- Messages:
Number of characters:
32 characters maximum
Number of messages:
100 messages (including 10 free messages)
- Message adding function:
Message can be added on historical display.
- Other display contents:
Status display area:
Date & time (year/month/day, hour:minute:second), batch name (batch number + lot number), login user name, display name, internal memory status, status indication icon
Trend display area:
Grid lines (number of divisions selectable from 4 to 12), hour : minutes on grid, trip levels (line widths are selectable from 1, 2 and 3 pixels)
- Data referencing function:
Display the retrieved data (display data or event data) from internal or external memory.
Display format:
Whole display or divided to 2 areas
Time axis operation:
Display magnification or reduction, scroll by key operation
- Display auto scroll function:
Display group of monitor display (trend display, bargraph display and digital display) automatically changes in a preset interval (5, 10, 20, 30 s and 1 min).
- LCD saver function:
The LCD backlight automatically dims or off (selectable) if no key is touched for a certain preset time (can be set from 1, 2, 5, 10, 30, and 60 min).
- Display register function:
Up to 8 display types can be registered with display name.
- Display auto return function:
The display type automatically returns to registered display type if no key is touched for a certain preset time (can be set from 1, 2, 5, 10, 20, 30 and 60 min)
- Temperature unit:
°C or °F selectable
- Data Saving Function**
- External storage medium:
Medium: CompactFlash memory card (CF card)
Format: FAT16 or FAT32
- Internal memory:
Medium: Flash memory
Capacity: Selectable from 80MB or 200MB
Maximum number of files can be saved:
400 files (total number of display data file and event data file)
- Manual saving:
Data files in internal memory can be saved manually. Selectable from all data saving or selected data saving.
Drive: CF card or USB flash drive (only for USB option)
- Automatic saving:
Display data:
Periodic saving to CF card
Event data:
In case of trigger free...Periodic saving to CF card
In case of using trigger...Save the data when sampling is finished

Data Saving Period:
Display data file:
 Linked with the waveform span rate
Event file: Linked with the specified sampling period
Event File Sampling Period:
 DX2004, DX2008:
 Selectable from 25, 125, 250, 500 ms, and 1, 2, 5, 10, 30, 60, 120, 300, and 600 s*
 DX2010, DX2020, DX2030, DX2040, DX2048:
 Selectable from 125, 250, 500 ms, and 1, 2, 5, 10, 30, 60, 120, 300, and 600 s*
 *Sampling period faster than measurement interval can not be selected.
Measurement data File:
 The following two file types can be created.
 Event file (stores instantaneous values sampled periodically at a specified sampling rate)
 Display data file (stores the maximum and minimum values for each waveform span rate from among measured data sampled at measurement intervals)
 Files can be created in the following combinations.
 (a) Event file + display data file
 (b) Display data file only
 (c) Event file only
Data format: YOKOGAWA private format (Binary)
Maximum data size per file:
 8,000,000 byte (8MB)
Data per channel:
Display data file:
 Measurement data.....4 byte/data
 Mathematical data.....8 byte/data
 External channel data..4 byte/data
Event data file:
 Measurement data.....2 byte/data
 Mathematical data.....4 byte/data
 External channel data..2 byte/data

Sampling time:
 The sampling time per file (8MB) during manual data saving can be determined by the formula "number of data items per channel x interval of data saving."
 This logic is explained in more detail below:
 1) When handling display data files only
 If we assume that the number of measuring channels is 30, the number of computing channels is 10, and the display update interval is 30 min/div (60 sec waveform span rate), then:
 Number of data items per channel = 8,000,000 bytes/(8 bytes(time stamp) + 30 x 4 bytes + 10 x 8 bytes) = 38,462 data items
 Sampling time per file = 38,462 x 60 sec = 2,307,720 sec = approx. 26 days
 2) When handling event files only
 If we assume that the number of measuring channels is 30, the number of computing channels is 10, and the data saving interval is 1 sec, then :
 Number of data items per channel = 8,000,000 bytes/(8 bytes(time stamp) + 30 x 2 bytes + 10 x 4 bytes) = 74,074 data items
 Sampling time per file = 74,074 x 1 sec = 74,074 sec = approx. 20 hours
 3) When handling both display data files and event files
 The sampling time is calculated by defining the size of data items in a display data file as 8,000,000 bytes and the size of data items in an event data file as 8,000,000 bytes. The method of calculation is the same as shown above.

Examples of Sampling Time for 1 file (8MB)*:
 *If sampling time exceeds 31 days, data file is divided.

In case measurement ch = 8 ch, mathematical ch = 0 ch

Display data file (approx.)

Waveform span rate (time/div)	15 s	30 s	1 min	2 min	5 min	10 min
Data saving period	0.5 s	1 s	2 s	4 s	10 s	20 s
Sampling time	27.8 h	2 days	4 days	9 days	23 days	46 days

Event data file (approx.)

Data saving period	25 ms	125 ms	0.5 s	1 s	2 s	5 s	10 s
Sampling time	2.3 h	11.6 h	46.3 h	3 days	7 days	19 days	38 days

In case measurement ch = 48 ch, mathematical ch = 60 ch

Display data file (approx.)

Waveform span rate (time/div)	15 s	1 min	5 min	10 min	20 min	30 min	1 h	2 h
Data saving period	NA	2 s	10 s	20 s	40 s	1 min	2 min	4 min
Sampling time	NA	6.5 h	32.7 h	2 days	5 days	8 days	16 days	32 days

Event data file (approx.)

Data saving period	25 ms	125 ms	0.5 s	1 s	10 s	30 s	1 min	2 min
Sampling time	NA	48 min	3.2 h	6.5 h	2 days	8 days	16 days	32 days

Manual sample data:
 The measuring and computing data can be saved manually to the internal memory and CF card.
Trigger: Key operation, communication command or event action function
Data format: ASCII
Max. number of data: 400 data (if exceeds 400 data, oldest data is overwritten)
Report data (only for MATH option):
Types: Hourly, daily, hourly + daily, daily + weekly, and daily + monthly
Data format: ASCII
Drive: CF card
Trigger function: Selectable from FREE or TRIG for event data saving.
Trigger mode: Selectable from free, single or repeat trigger
Data length: Selectable from 10, 20, 30 min, 1, 2, 3, 4, 6, 8, 12 hour, 1, 2, 3, 5, 7, 10, 14, 31 day
Pre trigger: Selectable from 0, 5, 25, 50, 75, 95, 100%
Trigger source: Key or event action function
Display hard copy:
Trigger: Key operation, communication command or event action function
Data format: png format
Drive/output: CF card or communication interface
Data file retrieving function: Data file in CF card or USB flash drive (only for USB option) can be retrieved and displayed.
Retrieved data file: Display data file or event data file
Saving and retrieving of configuration data: Configuration information can be saved and retrieved as ASCII data.
Drive: CF card or USB flash drive (only for USB option)

Alarm Function

Number of alarm levels: Up to four levels for each channel
Alarm types: High and low limits, differential high and low limits, high and low rate-of-change limits and delay high and low
Alarm delay time: 1 to 3600 s
Interval time of rate-of-change alarms: The measurement interval times 1 to 32
Display: The alarm status (type) is displayed in the digital value display area upon occurrence of an alarm. A common alarm indication is also displayed.
Alarming behavior: non-hold or hold-type can be selectable for common to all channels.
Hysteresis: On/off selectable (common to measurement channels, mathematical channels or external channels) 0.0 to 5.0% of display span (or scaling span)
Outputs: Output: Internal switch or relay output (optional)

Number of internal switch: 30 points
Internal switch action: AND/OR
Number of relay output points: 2, 4, 6, 12, 22 or 24 points (optional)
Relay action: Energized/deenergized, hold/non-hold, AND/OR, alarm reflash selectable.
Alarm no logging function: When alarm occurs, only internal switch or relay output is activated. There are no alarm display on screen and no record on alarm summary. On/off selectable for each channel and alarm level.
Memory: The times of alarm occurrences/recoveries, alarm types, etc. are stored in the memory. Up to 1000 latest alarm events are stored.

Event action function

General: Particular action can be executed by particular event.
Number of event action: 40 actions can be set
Event list:

Event	Level/Edge	Description
Remote	Level/Edge	Action by remote control signal
Relay	Level/Edge	Action by relay operation
Internal switch	Level/Edge	Action by internal switch operation
Alarm	Level/Edge	Action by any alarm
Timer	Edge	Action by timer time up
Match time	Edge	Action by time up of match time timer
USER key	Edge	Action by USER key operation

Action list:

Action	Level/Edge	Description
Memory start/stop	Level	Memory start and stop
Memory start	Edge	Memory start
Memory stop	Edge	Memory stop
Event trigger	Edge	Event data sampling start
Alarm ACK	Edge	Alarm ACK
Math start/stop	Level	Computation start and stop
Math start	Edge	Computation start
Math stop	Edge	Computation stop
Math reset	Edge	Computation reset
Manual sample	Edge	Manual sample
Snapshot	Edge	Save display image to external media
Message input	Edge	Message writing
Waveform span rate change	Level	Change waveform span rate
Display data save	Edge	Save currently sampled display data to internal memory as a file
Event data save	Edge	Save currently sampled event data to internal memory as a file
Relative time timer reset	Edge	Reset relative time timer
Display group change	Edge	Change to specified display group
Time adjustment	Edge	Adjust internal clock to the nearest hour
Flag	Level	Normal: "0", Event: "1"
Setting file load	Edge	Load setting file from CF card (up to 3 setting files).

Security functions

General: Login function or key lock function can be set for each key operation or communication operation.

Key lock function:
On/off and password can be set for each operation key and FUNC operation.

Login function:
User name and password to login can be set.
User level and number of users:

System administrator:	5 users
General users:	30 users

10 kinds of login mode can be set for general users.

Clock

Clock: With calendar function (year of grace)

Clock accuracy:
 ± 10 ppm, excluding a delay (of 1 second, maximum) caused each time the power is turned on.

Time setting method:
Key operation, communication command, event action function or SNTP client function

Time adjustment method:
During memory sample:
Adjust 40 ms per second (No influence for measurement period)

During memory stop:
Adjust at a time

Time zone:
Time difference from GMT:
Settable from -1300 to 1300

Date display format:
Selectable from YYYY/MM/DD, MM/DD/YYYY, DD/MM/YYYY or DD.MM.YYYY

DST function (summer/winter time):
The time at which the daylight savings time adjustment is automatically calculated and configured.

Communication Functions

Electrical specifications:
Confirms to IEEE802.3 (DIX specification for Ethernet frames)

Connection:
Ethernet (10BASE-T)

Protocols: TCP, UDP, IP, ICMP, ARP, DHCP, HTTP, FTP, SMTP, SNTP, Modbus, DX private

E-mail inform function:
E-mail is sent by events as below.

- Alarm occurring/alarm canceling
- Recover from power failure
- Memory end
- Storage medium error, FTP client function error
- Specified time period
- Report data time up (only for mathematical option)

FTP client function:
Data file auto-transfer from DX
Transferred data file:
Display data file, event data file, report data file and display image file

FTP server function:
File transfer from DX, file elimination, directory operation and file list output are available by request from host computer.

Web server function:
Display image of DX and alarm information can be displayed on web browser software

SNTP client function:
The time on DX can be synchronized to the time of a SNTP server.

SNTP server function:
The DX can operate as a SNTP server.

DHCP client function:
Network address configuration can be obtained automatically from DHCP server.

Obtained information:
IP address, subnet mask, default gateway and DNS information

Modbus client function:
Reading or writing of measurement data on other instruments are available by Modbus protocol.
Mathematical option or external input option is required to read the data from other instruments.

Modbus server function:
Output of measurement data from DX is available by Modbus protocol.

Setting/measurement server function:
Operation, setting or output of measurement data are available by DX private protocol.

Maintenance/test server function:
Output connection information or network information of the Ethernet communication.

Instrument information server function:
Output instrument information such as serial number or model name of DX.

Batch function

General: Data display and data management with batch name, text field function and batch comment function are available.

Batch name:
Batch name can be used as file name of display data, event data and report data.
Batch name format:

Batch number (max. 32 characters) + lot number (max. 8 characters)
Use/not use selectable for lot number, on/off selectable for auto increment function

Text field function:
Field number:
1 to 8

Field title:
Max. 20 characters

Field text:
Max. 30 characters

Batch comment function:
Batch comment is added to display data and event data.

Batch comment information:
3 comments (max. 50 characters) are available.

Power Supply

- Rated power supply:
100 to 240 VAC (automatic switching)
- Allowable power supply voltage range:
90 to 132 or 180 to 264 VAC
- Rated power supply frequency:
50/60 Hz (automatic switching)
- Power consumption:

Supply voltage	LCD off	Normal	Max.
100 VAC	28 VA	42 VA	74 VA
240 VAC	38 VA	54 VA	100 VA

- Allowable interruption time:
Less than 1 cycle of power supply frequency

Other Specifications

- Memory backup :
A built-in lithium battery backs up the setup parameters (battery life : approximately 10 years at room temperature).
- Insulation resistance:
Each terminal to ground terminal:
20 MΩ or greater (at 500 VDC)
- Dielectric strength:
Power supply to ground terminal:
2300 VAC (50/60 Hz), 1 min
- Contact output terminal to ground terminal:
1600 VAC (50/60 Hz), 1 min
- Measuring input terminal to ground terminal:
1500 VAC (50/60 Hz), 1 min
- Between measuring input terminals:
1000 VAC (50/60 Hz), 1 min (except for b-terminal of RTD input of DX2010, DX2020, DX2030, DX2040 and DX2048)
- Between remote control terminal to ground terminal:
1000 VDC, 1 min

Safety and EMC Standards

- CSA: CSA22.2 No61010-1
Installation category II^{*1}, pollution degree 2^{*2}
- UL: UL61010-1 (CSA NRTL/C)
- CE:
EMC directive:
EN61326 compliance (Emission: Class A, Immunity: Annex A)
EN61000-3-2 compliant
EN61000-3-3 compliant
EN55011 compliant, Class A Group 1
- Low voltage directive:
EN61010-1 compliant, measurement category II^{*3}, pollution degree 2^{*2}

C-Tick: AS/NZS CISPR11 compliant, Class A Group 1

- *1: Installation Category (Overvoltage Category) II
Describes a number which defines a transient overvoltage condition. It implies the regulation for impulse withstand voltage. "II" applies to electrical equipment which is supplied from fixed installations like distribution boards.
- *2: Pollution Degree
Describes the degree to which a solid, liquid, or gas which deteriorates dielectric strength or surface resistivity is adhering. "2" applies to normal indoor atmosphere. Normally, only non-conductive pollution occurs.
- *3: Measurement Category II
Applies to measuring circuits connected to low voltage installation, and electrical instruments supplied with power from fixed equipment such as electric switchboards.

Normal Operating Conditions

- Power voltage:
90 to 132 or 180 to 250 VAC
- Power supply frequency:
50 Hz $\pm 2\%$, 60 Hz $\pm 2\%$
- Ambient temperature:
0 to 50 °C
- Ambient humidity:
20% to 80% RH (at 5 to 40 °C)
- Vibration: 10 to 60 Hz, 0.2 m/s² or less
- Shock: Not acceptable
- Magnetic field:
400 AT/m or less (DC and 50/60 Hz)
- Noise:
Normal mode (50/60 Hz):
DCV: The peak value including the signal must be less than 1.2 times the measuring range.
TC: The peak value including the signal must be less than 1.2 times the measuring thermal electromotive force.
RTD: 50 mV or less
- Common mode noise voltage (50/60 Hz):
250 Vrms AC or less for all ranges
- Maximum noise voltage between channels (50/60 Hz):
250 Vrms AC or less
- Mounting position:
Can be inclined up to 30 deg backward.
Mounting at an angle away from the perpendicular is not acceptable.
- Warm-up time:
At least 30 min after power on
- Installation location:
In-room
- Altitude: Less than 2000 m

Standard Performance

Measuring and Recording Accuracy:

The following specifications apply to operation of the recorder under standard operation conditions.

Temperature:

23 ± 2 °C

Humidity:

55% ± 10% RH

Power supply voltage:

90 to 132 or 180 to 250 VAC

Power supply frequency:

50/60 Hz ± 1%

Warm-up time:

At least 30 min.

Other ambient conditions such as vibration should not adversely affect recorder operation.

Input	Range	Measurement accuracy (digital display)		Max. resolution of digital display
		A/D integration time: 16.7ms or more	A/D integration time: 1.67ms (fast sampling mode)	
DCV	20 mV	±(0.05% of rdg + 12 digits)	±(0.1% of rdg + 40 digits)	1 μV
	60 mV			10 μV
	200 mV	±(0.05% of rdg + 3 digits)	±(0.1% of rdg + 15 digits)	10 μV
	2 V	±(0.05% of rdg + 12 digits)	±(0.1% of rdg + 40 digits)	100 μV
	6 V			1 mV
	1-5 V			1 mV
	20 V	±(0.05% of rdg + 3 digits)	±(0.1% of rdg + 15 digits)	1 mV
	50 V			10 mV
TC (Excluding RJC accuracy)	R	±(0.15% of rdg + 1°C) However, R, S:	±(0.2% of rdg + 4°C) However, R, S:	0.1°C
	S	±3.7°C at 0 to 100°C ±1.5°C at 100 to 300°C B:	±10°C at 0 to 100°C ±5°C at 100 to 300°C B:	
	B	±2°C at 400 to 600°C Accuracy at less than 400°C is not guaranteed.	±7°C at 400 to 600°C Accuracy at less than 400°C is not guaranteed.	
	K	±(0.15% of rdg + 0.7°C) However, ±(0.15% of rdg + 1°C) at -200 to -100°C	±(0.2% of rdg + 3.5°C) However, ±(0.15% of rdg + 6°C) at -200 to -100°C	
	E			
	J	±(0.15% of rdg + 0.5°C) However,	±(0.2% of rdg + 2.5°C) However,	
	T	±(0.15% of rdg + 0.7°C) at -200 to -100°C	±(0.2% of rdg + 5°C) at -200 to -100°C	
	L			
	U			
	N	±(0.15% of rdg + 0.7°C)	±(0.3% of rdg + 3.5°C)	
W	±(0.15% of rdg + 1°C)	±(0.3% of rdg + 7°C)		
WRe	±(0.2% of rdg + 2.5°C) However, ±4°C at 0 to 200°C	±(0.3% of rdg + 10°C) However, ±18°C at 0 to 200°C		
RTD	Pt100			
	JPt100	±(0.15% of rdg + 0.3°C)	±(0.3% of rdg + 1.5°C)	

Measurement accuracy in case of scaling (digits):
 = measurement accuracy (digits) x scaling span (digits)/measurement span (digits) + 2 digits
 Decimals are rounded off to the next highest number.

Reference junction compensation:
 INT (internal)/EXT (external) selectable (common for all channels)

Reference junction compensation accuracy:
 Types R, S, B, W, WRe: $\pm 1\text{ }^{\circ}\text{C}$
 Types K, J, E, T, N, L, U: $\pm 0.5\text{ }^{\circ}\text{C}$
 (Above $0\text{ }^{\circ}\text{C}$, input terminal temperature is balanced)

Maximum allowable input voltage:
 $\pm 60\text{ VDC}$ (continuous) for all input ranges

Input resistance:
 Approx. $10\text{ M}\Omega$ or more for DCV ranges of 200 mVDC or less and TC
 Approx. $1\text{ M}\Omega$ for more than 2 VDC ranges

Input source resistance:
 DCV, TC: $2\text{ k}\Omega$ or less
 RTD: $10\text{ }\Omega$ or less per wire (The resistance of all three wires must be equal.)

Input bias current:
 10 nA or less (approx. 100 nA for TC range with burnout function)

Maximum common mode noise voltage:
 250 Vrms AC (50/60 Hz)

Maximum noise voltage between channels:
 250 Vrms AC (50/60 Hz)

Interference between channels:
 120 dB (when the input source resistance is $500\text{ }\Omega$ and the inputs to other channels are 60 V)

Common mode rejection ratio:
 A/D integration time 20 ms:
 More than 120 dB ($50\text{ Hz} \pm 0.1\%$, $500\text{ }\Omega$ imbalance between the minus terminal and ground)
 A/D integration time 16.7 ms:
 More than 120 dB ($60\text{ Hz} \pm 0.1\%$, $500\text{ }\Omega$ imbalance between the minus terminal and ground)
 A/D integration time 1.67 ms:
 More than 80 dB ($50/60\text{ Hz} \pm 0.1\%$, $500\text{ }\Omega$ imbalance between the minus terminal and ground)

Normal mode rejection ratio:
 A/D integration time 20 ms:
 More than 40 dB ($50\text{ Hz} \pm 0.1\%$)
 A/D integration time 16.7 ms:
 More than 40 dB ($60\text{ Hz} \pm 0.1\%$)
 A/D integration time 1.67 ms:
 $50/60\text{ Hz}$ is not rejected.

Effects of Operating Conditions

Ambient temperature: (Only for 16.7 ms A/D integration time or more)

With temperature variation of $10\text{ }^{\circ}\text{C}$
 DCV, TC: $\pm (0.1\%$ of rdg + 0.05% of range) or less
 Excluding the error of reference junction compensation
 RTD: $\pm (0.1\%$ of rdg + 2 digits) or less

Power supply:
 With variation within 90 to 132 V and 180 to 250 VAC (50/60 Hz):

Within measurement accuracy
 With variation of $\pm 2\text{ Hz}$ from rated power frequency (at 100 VAC):

Within measurement accuracy

Magnetic field:

AC (50/60 Hz) and DC 400 A/m fields:
 $\pm (0.1\%$ of rdg + 10 digits) or less

Input source resistance:

(1) DCV range (with variation of $+1\text{ k}\Omega$)

200 mVDC range or less:
 $\pm 10\text{ }\mu\text{V}$ or less

2 VDC range or greater:
 $\pm 0.15\%$ of rdg or less

(2) TC range (with variation of $+1\text{ k}\Omega$)
 $\pm 10\text{ }\mu\text{V}$

(3) RTD range (Pt100)

With variation of $10\text{ }\Omega$ per wire (resistance of all three wires must be equal):

$\pm (0.1\%$ of rdg + 1 digit) or less

With maximum difference of $40\text{ m}\Omega$ between wires:
 approx. $\pm 0.1\text{ }^{\circ}\text{C}$

Transport and Storage Conditions

The following specifies the environmental conditions required during transportation from shipment to the start of service and during storage as well as during transportation and storage if this instrument is temporarily taken out of service.

No malfunction will occur under these conditions without serious damage, which is absolutely impossible to repair; however, calibration may be necessary to recover normal operation performance.

Ambient temperature:

$-25\text{ }^{\circ}\text{C}$ to $60\text{ }^{\circ}\text{C}$

Humidity: 5% to 95% RH (No condensation is allowed.)

Vibration: 10 to 60 Hz , 4.9 m/s^2 maximum

Shock: 392 m/s^2 maximum (while being packed)

SPECIFICATIONS OF OPTIONAL FUNCTIONS

Alarm Output Relays (/A1, /A2, /A3, /A4, /A5)

An alarm signal is output from the rear panel as a relay contact signal.

Number or output:

Select from 2, 4, 6, 12 and 24 points

Relay contact rating:

250 VDC/0.1 A (for resistance load), 250 VAC (50/60 Hz)/3 A

Terminal configuration:

SPDT (NO-C-NC). Energized-at-alarm/deenergized-at-alarm, AND/OR, and hold/non-hold actions are selectable.

Serial Communication Interface (/C2, /C3)

Connection:

EIA RS-232 (/C2) or RS-422A/485 (/C3)

Protocols: DX private protocol, Modbus(master/slave) protocol

Synchronization method:

Start-stop asynchronous transmission

Connection method (RS-422A/485):

4-wire half-duplex multi-drop connection (1 : N, N = 1 to 31)

Transmission speed:

1200, 2400, 4800, 9600, 19200 or 38400 bps

Data length:

7 or 8 bits

Stop bit: 1 bit

Parity: Odd, even, or none

Communication distance (RS-422A/485):

Up to 1.2 km

Communication mode:

ASCII for input/output for control and setting
ASCII or binary for output of measured data

Setting/measurement server function:

Operation, setting or output of measurement data are available by DX private protocol.

Modbus communication:

Reading or writing of measurement data on other instruments are available by Modbus protocol.
Mathematical function option or external input option is needed to read measurement data from other instruments.

Operation mode:

RTU MASTER or RTU SLAVE

Modbus master command number:

1 to 16

VGA Video Output (/D5)

Resolution: 640 x 480 pixels (VGA)

Connector: 15 pins D-SUB (DB15HD)

Fail/Status Output (/F1)

The relay contact output on the rear panel indicates the occurrence of CPU failure or selected status.

FAIL output relay:

The relay contact output on the rear panel indicates the occurrence of CPU failure.

Relay operation: CPU normal: Energized,
CPU failure: Deenergized

Status output relay:

The relay contact output on the rear panel indicates the occurrence of selected status

Relay operation: Status detection:
Energized

Status	Description
Memory status	Relay is energized when internal memory or external storage media is in the following conditions: Abnormality in the internal memory When automatic saving of settings to the external storage media is ON <ul style="list-style-type: none"> • When the remaining space on the external storage medium reaches 10%. • When an abnormality occurs with the external storage medium, and auto save fails • When the external storage medium is not inserted, operation is same as when automatic saving of settings to the external storage media is Off When automatic saving of settings to the external storage media is Off <ul style="list-style-type: none"> • When the remaining space on the internal memory reaches 10% • When the number of data file which is not saved to external storage media exceeds 390 *Not including USB memory connected to the instrument.
Measurement Failure	Relay energized upon A/D converter abnormality or burnout detection
Comm. failure	Relay energized when communication error occurs in the Modbus master
Memory stop	Relay energized upon memory stop

Relay contact rating:

250 VDC/0.1 A (for resistance load), 250 VAC (50/60 Hz)/3A

Fail & Alarm Output Relays 22 points (/F2)

Combination of "Fail/Memory end output function" and "Alarm output relays 22 points".

Clamped Input Terminal (/H2)

Clamped input terminal (detachable type) is used for input terminal.

Available wire size:

0.08 to 1.5 mm² (AWG28 to16)

Desk Top Type (/H5 [], /H5*)

Provides carrying handle and power cord.

* In case that /P1 is specified together, /H5 must be specified. Power terminal will be screw type and power code will not be provided.

Mathematical Functions (/M1)

Used for calculating data, displaying trends and digital values, and recording calculated data assigned to channels.

Channel assignable to calculated data:

DX2004, DX2008:

Up to 12 channels (101 to 112)

DX2010, DX2020, DX2030, DX2040, DX2048:

Up to 60 channels (101 to 160)

Max. character length of expression:

120 characters

Operation:

General arithmetic operations:

Four arithmetic operations, square root, absolute, common logarithm, natural logarithm, exponential, power, relational operations (>, ≥, <, ≤, =, ≠), logic operations (AND, OR, NOT, XOR)

Statistical operations:

TLOG (Average, maximum, minimum, summation and P-P value of time series data)

CLOG (Average, maximum, minimum, summation and P-P value of channel series data)

Special operations:

- PRE (Previous data)
- HOLD(a):b (Hold data of "b" in case of "a" is not "0")
- RESET(a):b (Reset data of "b" and restart in case of "a" is not "0")
- CARRY(a):b (If "b" exceeds "a", "b-a" becomes computation results)

Conditional operation:

- [a?b:c] (Execute "b" in case of "a" is not "0", or execute "c" in case of "a" is "0")

Constant: Up to 60 constants (K01 to K60)

Digital data input via communication: Up to 60 data (C01 to C60)

External input: Up to 240 data (201 to 440) (only for external input option)

Remote status input: Remote input status (0/1) can be used in mathematical expression

- Up to 8 inputs (D01 to D08)

Pulse input: Up to 8 pulse count input (P01 to P08, Q01 to Q08) (only for pulse input option)

Status input: Internal switch status (S01 to S30), relay status (I01 to I36) and flag status (F01 to F08) can be used in mathematical expression

Report functions:

Number of report channels:
DX2004, DX2008: up to 12 channels
DX2010, DX2020, DX2030, DX2040: up to 60 channels

Report type:
Hourly, daily, hourly + daily, daily + weekly and daily + monthly

Operation:
Max. 4 types are selectable from average, maximum, minimum, instantaneous and summation

Data format:
ASCII

Long term rolling average:
Computation interval:
1, 2, 3, 4, 5, 6, 10, 12, 15, 20, 30 sec., 1, 2, 3, 4, 5, 6, 10, 12, 15, 20, 30, 60 min

Number of sampling:
1 to 1500

Cu10, Cu25 RTD Input /3 leg isolated RTD Input (/N1)

This option allows Cu10 and Cu25 inputs to be added to the standard input types.

A, B, b legs are of isolated input type for DX2010, DX2020, DX2030, DX2040 and DX2048.

Input type Measuring range:

The following specifications apply to operation of the recorder under standard operation conditions.

Temperature:

23 ± 2 °C

Humidity:

55% ± 10% RH

Power supply voltage:

90 to 132 or 180 to 250 VAC

Power supply frequency:

50/60 Hz ± 1%

Warm-up time:

At least 30 min.

Other ambient conditions such as vibration should not adversely affect recorder operation.

Input	Type	Measurement range	Accuracy guarantee d range	Measurement accuracy		Max. resolution of digital display
				A/D integration time: 16.7 ms or more	A/D integration time: 1.67ms (Fast sampling mode)	
RTD *1	Cu10 (GE)	-200 to 300°C	-70 to 170°C	±(0.4% of rdg + 1.0°C)	±(0.8% of rdg + 5.0°C) RTD	0.1°C
	Cu10 (L&N)		-75 to 150°C			
	Cu10 (WEED)		-200 to 260°C			
	Cu10 (BAILEY)		-200 to 300°C	±(0.3% of rdg + 0.8°C)	±(0.5% of rdg + 2.0°C)	
	Cu10:α =0.00392 at 20°C					
	Cu10:α =0.00393 at 20°C					
Cu25:α =0.00425 at 0°C						

*1 Measuring current: i = 1mA

Input source resistance:

1 Ω or less per wire (The resistance of all three wires must be equal.)

Ambient temperature: (Only for 16.7 ms A/D integration time or more)

With temperature variation of 10 °C

± (0.2% of rdg + 2 digits) or less

Input source resistance:

With variation of 1 Ω per wire (resistance of all three wires must be equal):

± (0.1% of rdg + 1 digit) or less

With maximum difference of 40 mΩ between wires:

approx. ± 1 °C

3 legs Isolated RTD Input (/N2)

A, B, b legs are of isolated input type.

* Can be specified only for DX2010, DX2020, DX2030, DX2040 and DX2048.

A, B, b legs of DX2004 and DX2008 are isolated as standard.

Extended Input Types (/N3)

This option allows extra inputs types to be added to the standard input types.

Input type Measuring range:

The following specifications apply to operation of the recorder under standard operation conditions.

Temperature:

23 ± 2 °C

Humidity: 55% ± 10% RH

Power supply voltage:

90 to 132 or 180 to 250 VAC

Power supply frequency:

50/60 Hz ± 1%

Warm-up time:

At least 30 min.

Other ambient conditions such as vibration should not adversely affect recorder operation.

Input	Type	Measurement range	Measurement accuracy		Max. resolution of digital display
			A/D integration time: 16.7 ms or more	A/D integration time: 1.67ms (Fast sampling mode)	
TC	Kp vs Au7Fe	0.0 to 300.0K	Within ±4.5K at 0 to 20K Within ±2.5K at 20 to 300K	Within ±13.5K at 0 to 20K Within ±7.5K at 20 to 300K	0.1 K
	PLATINEL	0.0 to 1400.0°C	±(0.25% of rdg+2.3°C)	±(0.25% of rdg+8.0°C)	0.1°C
	PR40-20	0.0 to 1900.0°C	Accuracy is not guaranteed at 0 to 450°C ±(0.9% of rdg+3.2°C) at 450 to 750°C ±(0.9% of rdg+1.3°C) at 750 to 1100°C ±(0.9% of rdg+0.4°C) at 1100 to 1900°C	Accuracy is not guaranteed at 0 to 450°C ±(0.9% of rdg+15.0°C) at 450 to 750°C ±(0.9% of rdg+6.0°C) at 750 to 1100°C ±(0.9% of rdg+3.0°C) at 1100 to 1900°C	
	NiNiMo	0.0 to 1310.0°C	±(0.25% of rdg+0.7°C)	±(0.5% of rdg+3.5°C)	
	W/WRe	0.0 to 2400.0°C	±15.0°C at 0 to 400°C ±(0.2% of rdg+2.0°C) at 400 to 2400°C	±30.0°C at 0 to 400°C ±(0.4% of rdg+4.0°C) at 400 to 2400°C	
	TypeN(AWG14)	0.0 to 1300.0°C	±(0.2% of rdg+1.3°C)	±(0.5% of rdg+7.0°C)	
RTD *1	Pt50	-200.0 to 550.0°C	±(0.3% of rdg+0.6°C)	±(0.6% of rdg+3.0°C)	0.1 K
	Ni100(SAMA)	-200.0 to 250.0°C	±(0.15% of rdg+0.4°C)	±(0.3% of rdg+2.0°C)	
	Ni100(DIN)	-60.0 to 180.0°C	±(0.15% of rdg+0.4°C)	±(0.3% of rdg+2.0°C)	
	Ni120	-70.0 to 200.0°C	±(0.15% of rdg+0.4°C)	±(0.3% of rdg+2.0°C)	
	J263*B	0.0 to 300.0 K	Within ±3.0K at 0 to 40K Within ±1.0K at 40 to 300K	Within ±9.0K at 0 to 40K Within ±3.0K at 40 to 300K	0.1°C
	Cu53	-50.0 to 150.0°C	±(0.15% of rdg+0.8°C)	±(0.3% of rdg+4.0°C)	
	Cu100	-50.0 to 150.0°C	±(0.2% of rdg+1.0°C)	±(0.4% of rdg+5.0°C)	
	Pt25	-200.0 to 550.0°C	±(0.15% of rdg+0.6°C)	±(0.3% of rdg+3.0°C)	

*1 Measuring current: i = 1mA

Input source resistance:

TC: 2 kΩ or less

RTD: 1 Ω or less per wire (The resistance of all three wires must be equal.)

Ambient temperature: (Only for 16.7 ms A/D integration time or more)

With temperature variation of 10 °C

TC: ± (0.1% of rdg + 0.05% of range) or less Excluding the error of reference junction compensation.

RTD: ± (0.2% of rdg + 2 digits) or less

Input source resistance:

(1) TC range (with variation of + 1 kΩ)

±10 μV

(2) RTD range

With variation of 1 Ω per wire (resistance of all three wires must be equal):

± (0.1% of rdg + 1 digit) or less

With maximum difference of 100 mΩ between wires: approx. ± 1 °C

24 VDC/AC Power Supply (/P1)

Rated power supply: 24 VDC or 24 VAC (50/60Hz)

Allowable power supply voltage range:

21.6 to 26.4 VDC/AC

Insulation resistance:

Power supply to ground terminal: 20 MΩ or greater (at 500 VDC)

Dielectric strength:

Power supply to ground terminal: 500 VAC

(50/60 Hz), 1 min

Max. power consumption:

Supply voltage	LCD off	Normal	Max.
24 VDC	12 VA	20 VA	45 VA
24 VAC (50/60 Hz)	20 VA	34 VA	70 VA

Remote Control (/R1)

This option allows eight functions to be controlled remotely by a contact input.

Please refer the part of "Event action function" for functions to be controlled.

24 VDC transmitter power supply (/TPS4, /TPS8)

Output voltage:

22.8 to 25.2 VDC (rated load current)

Rated output current:

4 to 20 mAADC

Max. output current:

25 mAADC (current to guard operation against overcurrent: approx. 68 mAADC)

Allowable conductor resistance:

RL ≤ (17.8 - transmitter minimum operation voltage)/0.02 A (not include drop voltage with load shunt resistance)

Max. length of wiring:

2 km (CEV cable)

Insulation resistance:

output terminal to grand terminal more than 20 MΩ (500 VDC)

Dielectric strength:
 Output terminal to grand terminal:
 500 VAC (50/60 Hz, I = 10 mA), 1 min
 Between output terminal:
 500 VAC (50/60 Hz, I = 10 mA), 1 min

Easy text entry (/KB1, /KB2)

Normal operating conditions:
 Ambient temperature for usage:
 0 to 40 °C
 Ambient humidity for usage:
 20 to 80% RH (When 5 to 40 °C, no condensation)
 Ambient temperature for storage:
 -10 to 60 °C
 Power supply:
 AA dry battery × 2
 Weight: Approx. 60 g (excluding dry battery)
 Dimensions: 170 (W) × 50 (H) × 23.7 (D) mm
 Number of units that can be controlled:
 Max. 32 units by ID setting
 Communication distance:
 Max. 8 m (depending on battery strength and usage area)
 Orientation specifications:
 Depends on battery strength & usage area

USB interface (/USB1)

USB interface specification:
 Based on Rev1.1, host function
 Number of ports:
 2 ports (Front and rear panel)
 Power supply:
 5V, 500mA (for each port)*1
 Available USB devices:
 Keyboard: 104/89 keyboard (US) based on USB HID Class Ver.1.1
 External medium:
 USB flash drive (some of USB flash drives may not be supported by DXAdvanced)
 *1: For low powered devices (bus power < 100 mA):
 5V ± 5%
 For high powered devices (bus power < 500 mA):
 5V ± 10%
 Devices which need more than 500 mA total bus power for 2 ports can not be connected at the same time.

Pulse input (/PM1)

Pulse input option includes mathematical functions option (/M1) and remote control option (/R1).
 Number of inputs:
 3 points (8 points are available in case of using remote inputs)
 Input format:
 Photocoupler isolation (shared common)
 Isolated power supply for input terminal (approx. 5 V)
 Input type:
 Non-voltage contact:
 Close: 200 Ω or less, Open: 100 kΩ or more
 Open collector:
 ON: 0.5 V or less (30 mADC), Leakage current of OFF: 0.25 mA or less
 Counting: Counts rising edges of pulses
 Allowable input voltage:
 30 VDC
 Max. sampling pulse period:
 Max. 100 Hz
 Minimum pulse length:
 5 ms

Pulse detection period:
 Approx. 3.9 ms (256Hz)
 Pulse measuring accuracy:
 ±1 pulse (for instantaneous mode)
 Pulse count period:
 Counts the number of pulse per measurement period (P01 to P08) or per second (Q01 to Q08).

Calibration correction function (/CC1)

Corrects the measurement value of each channel using segment linearizer approximation.
 Number of segment points:
 2 to 16

External input function (/MC1)

Digital input channels via communication or Modbus master function are extended to input data from other instruments*.
 Number of external input channels:
 Up to 240 channels (channel number: 201 to 440)
 * Only for DX2010, DX2020, DX2030, DX2040 and DX2048
 * Fast sampling mode is not available with external input function option.

APPLICATION SOFTWARE**DAQSTANDARD for DXAdvanced**

Operating environment
 OS: Microsoft Windows 2000/XP
 Processor: Pentium II 333 MHz or higher (Pentium III 600 MHz or higher recommended)
 Memory: Free area of 32 MB or more (128 MB or more recommended)
 Disk device:
 CD-ROM drive that is applied to Windows 2000/XP
 Hard disk: Free area of at least 100 MB
 Display card:
 Compatible with Windows 2000/XP
 Can display 32,000 colors or higher (64,000 colors or higher recommended)
 Printer: A printer and printer driver compatible with Windows 2000/XP
 Basic function (packages)
 Configuration software:
 External memory medium: configuration of setting and basic setting mode
 Configuration via communication: configuration of setting and basic setting mode without communication configuration (ex. IP address)
 Data viewer software:
 Numbers of display channels:
 32 channels for each group, at most 50 groups
 Display function:
 Waveform display, digital display, circular display, list display, report display etc.
 File connection display:
 Connect data files that are divided because of auto-save during continuous data collecting or power failure, and then display (can connect up to total 5 million)
 Section computation:
 Maximum, minimum, average, effective and P-P value
 Data conversion:
 File conversion to ASCII, Lotus 1-2-3 or MS-Excel format
 Print out: Print out displayed data

MODEL AND SUFFIX CODES

Model code	Suffix code	Optional code	Description
DX2004			4ch, 125ms (Fast sampling mode: 25ms)
DX2008			8ch, 125ms (Fast sampling mode: 25ms)
DX2010			10ch, 1s (Fast sampling mode: 125ms)
DX2020			20ch, 1s (Fast sampling mode: 125ms)
DX2030			30ch, 1s (Fast sampling mode: 125ms)
DX2040			40ch, 1s (Fast sampling mode: 125ms)
DX2048			48ch, 1s (Fast sampling mode: 125ms)
Internal memory	-1		Standard memory (80MB)
	-2		Large memory (200MB)
External media		-4	CF card (with media)
Display language		-2	English/German/French, degF, DST(summer/winter time)
Options		/A1	Alarm output 2 points *1
		/A2	Alarm output 4 points *1
		/A3	Alarm output 6 points *1
		/A4	Alarm output 12 points *1
		/A5	Alarm output 24 points *1 *2
		/C2	RS-232 interface *3
		/C3	RS-422A/485 interface *3
		/D5	VGA output
		/F1	FAIL/Status output *2 *4
		/F2	FAIL + Alarm output 22 points *1 *4
		/H2	Clamped input terminal (detachable)
		/H5	Desktop type (only for /P1 model, without power cable, screw type power terminal) *5
		/H5[]	Desktop type *6
		/M1	Mathematical functions
		/N1	Cu10,Cu25 RTD input/3 leg isolated RTD
		/N2	3 leg isolated RTD *7
		/N3	Extended input type (PR40-20, Pt50, etc.)
		/P1	24VDC/AC power supply
		/R1	Remote control
		/TPS4	24VDC transmitter power supply (4 loops) *8
	/TPS8	24VDC transmitter power supply (8 loops) *9	
	/KB1	Easy text entry (with input terminal) *10 *11	
	/KB2	Easy text entry (without input terminal) *10	
	/USB1	USB interface	
	/PM1	Pulse input (including remote control and mathematical functions) *12	
	/CC1	Calibration correction function	
	/MC1	External input function *13	

*1 /A1, /A2, /A3, /A4, /A5, /F2 cannot be specified together.

*2 /A5 and /F1 cannot be specified together.

*3 /C2 and /C3 cannot be specified together.

*4 /F1 and /F2 cannot be specified together.

*5 In case that 24 VDC/AC power supply (/P1) and desktop type are specified together, /H5 must be specified.

/P1 and /H5[] cannot be specified together.

*6 /H5[]

- D: Power cord UL, CSA st'd
- F: Power cord VDE st'd
- R: Power cord SAA st'd
- J: Power cord BS st'd
- H: Power cord GB st'd

*7 /N2 can be specified for only DX2010, DX2020, DX2030, DX2040 and DX2048.

*8 /TPS4, /TPS8, /A5 and /F2 cannot be specified together.

*9 In case that /TPS8 is specified, combination of /A4/F1 cannot be specified together.

*10 /KB1 and /KB2 cannot be specified together.

*11 In case that /KB1 is specified, remote input terminal (438227) is included.

*12 In case that /PM1 is specified, /A5, /F2, /M1 and /R1 cannot be specified. And combination of /A2/F1 and combination of /A4/TPS8 cannot be specified together.

*13 /MC1 can be specified for only DX2010, DX2020, DX2030, DX2040 and DX2048.

Application Software

Model code	Description	O S
DXA120	DAQSTANDARD for DXAdvanced	Windows 2000/XP

STANDARD ACCESSORIES

Product	Qty
Mounting brackets	2
Terminal screws	5
Door lock key	2
Operation guide	1
Instruction manual (CD-ROM)	1
DAQSTANDARD software (CD-ROM)	1
CF card (32MB)	1
Power cable *1	1

*1 For /H5[] option

For / KB1 option

Product	Qty
Remote control terminal (438227)	1
AA alkali dry battery	2
Labels for remote control terminal	2

OPTIONAL ACCESSORIES

Product	Model code (part number)	Specification
Shunt resistor (for screw input terminal)	415920	250 $\Omega \pm 0.1\%$
	415921	100 $\Omega \pm 0.1\%$
	415922	10 $\Omega \pm 0.1\%$
Shunt resistor (for clamped input terminal)	438920	250 $\Omega \pm 0.1\%$
	438921	100 $\Omega \pm 0.1\%$
	438922	10 $\Omega \pm 0.1\%$
CF card adapter	772090	–
CF card	772091	128MB
	772092	256MB
	772093	512MB
	772094	1GB
Mounting bracket	B9900BX	–
Door lock key	B8706FX	–
Remote control terminal	438227	For /KB1, /KB2 option

DIMENSIONS

Dimensions

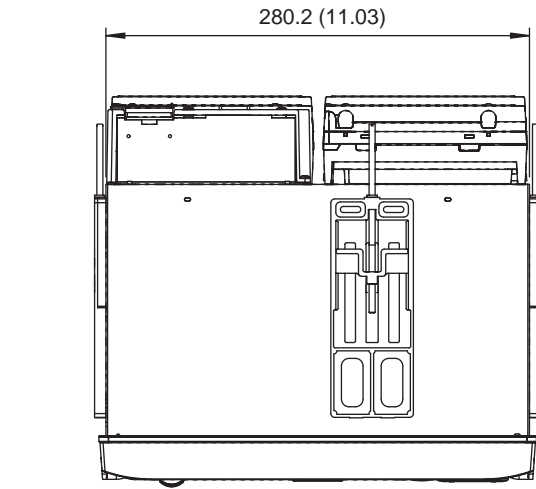

Panel Cutout & Spacing

Unit : mm
(approx.inch)

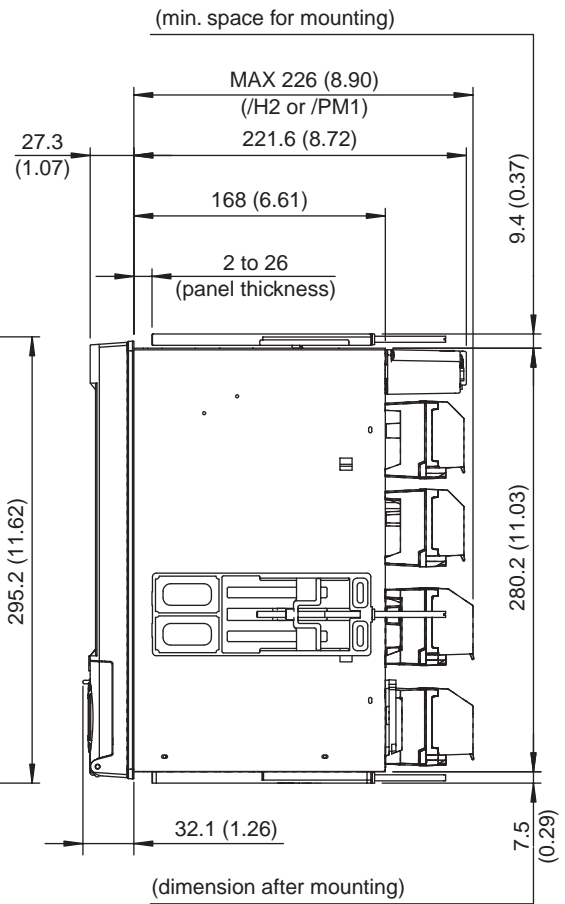
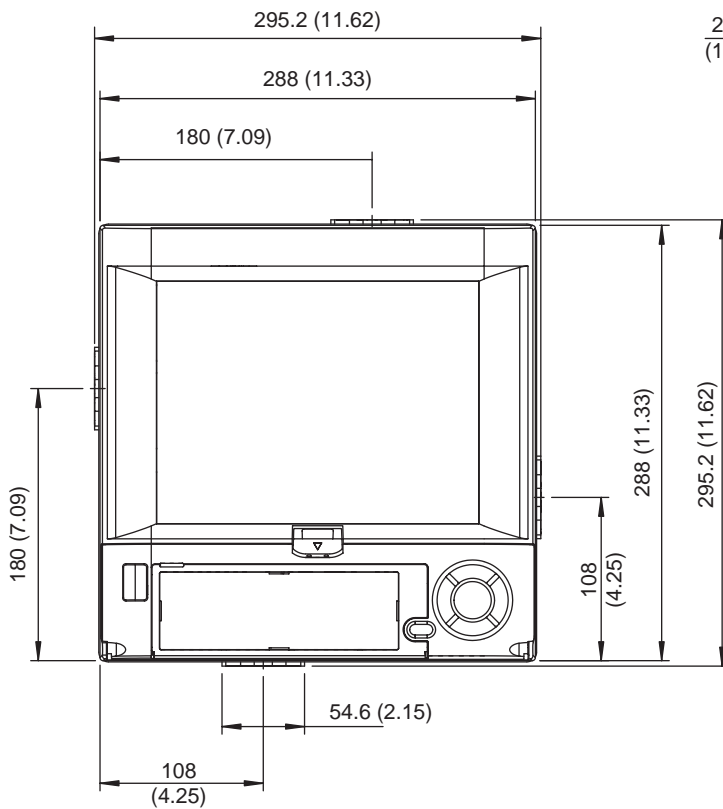
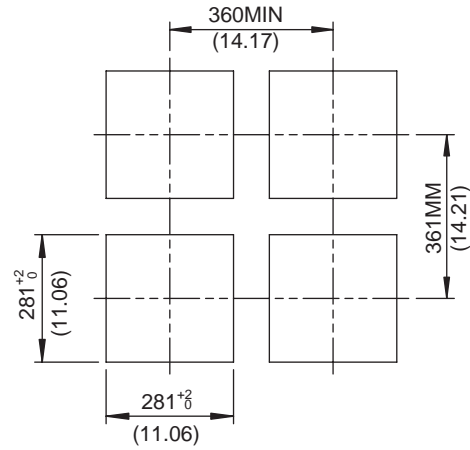

Note: If not specified, the tolerance is $\pm 3\%$. However, for dimensions less than 10mm, the tolerance is $\pm 0.3\text{mm}$.

Desk-top type

Unit : mm
(approx.inch)

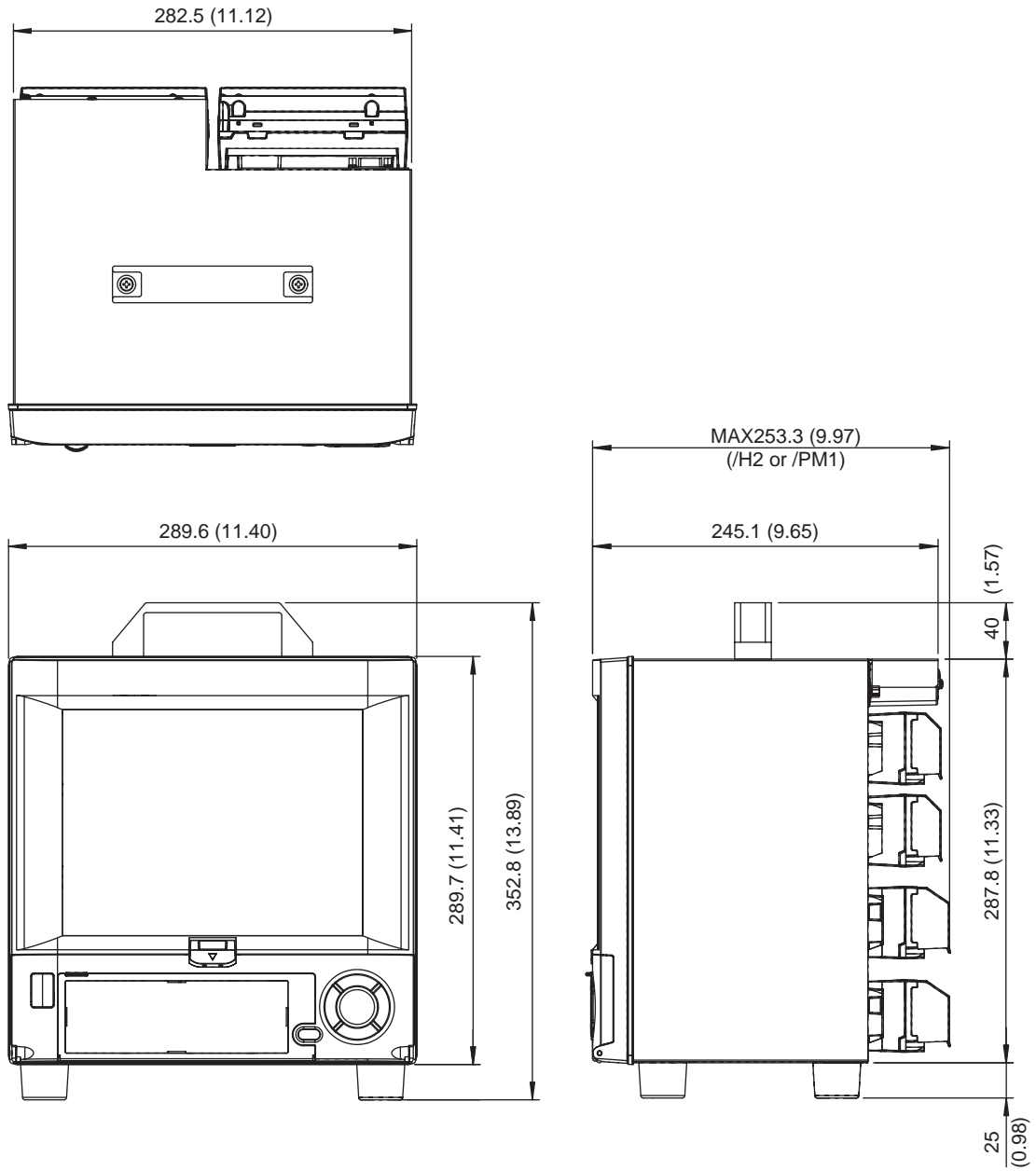

Note: If not specified, the tolerance is $\pm 3\%$. However, for dimensions less than 10mm, the tolerance is $\pm 0.3\text{mm}$.

Rear View

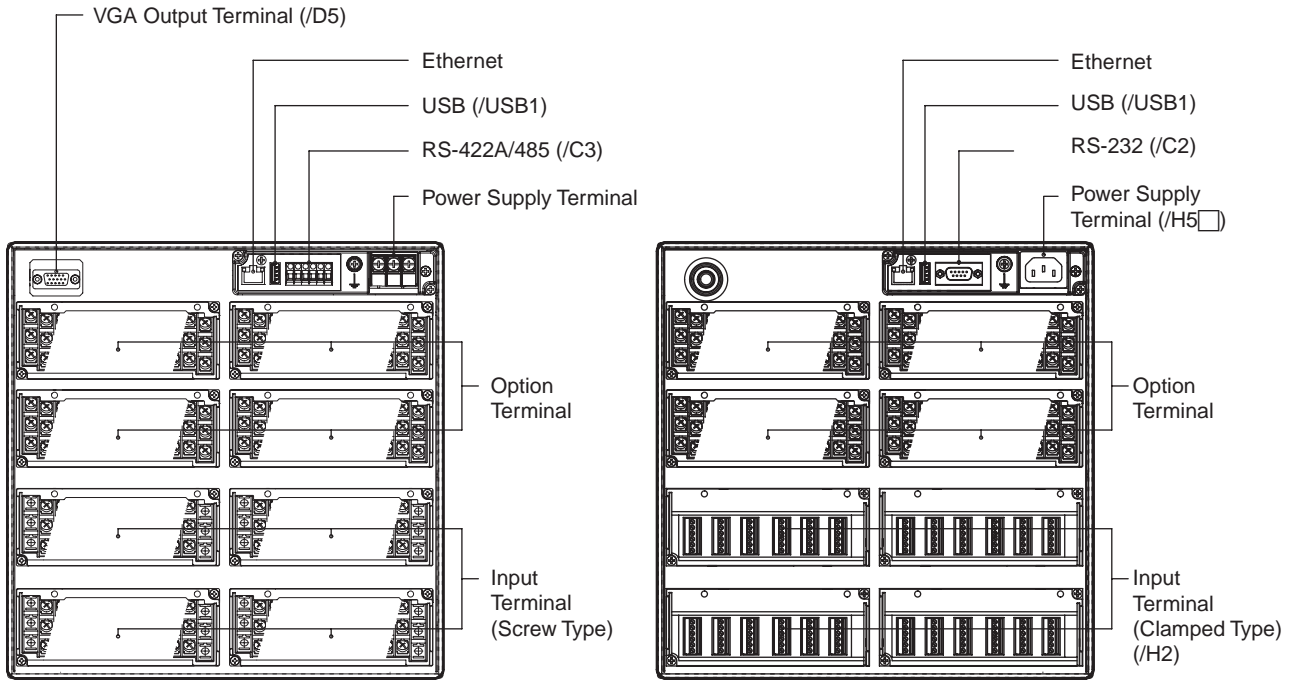

Power Supply Terminal

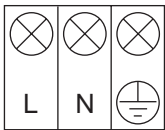

RS-422-A/485 Terminal

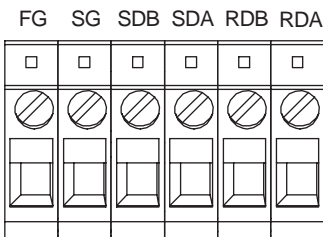

RS-232 Terminal

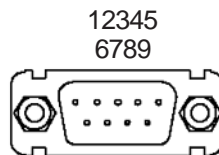

1	N.C.
2	RD
3	SD
4	N.C.
5	SG
6	N.C.
7	RS
8	CS
9	N.C.

Input Terminals

Screw Terminals

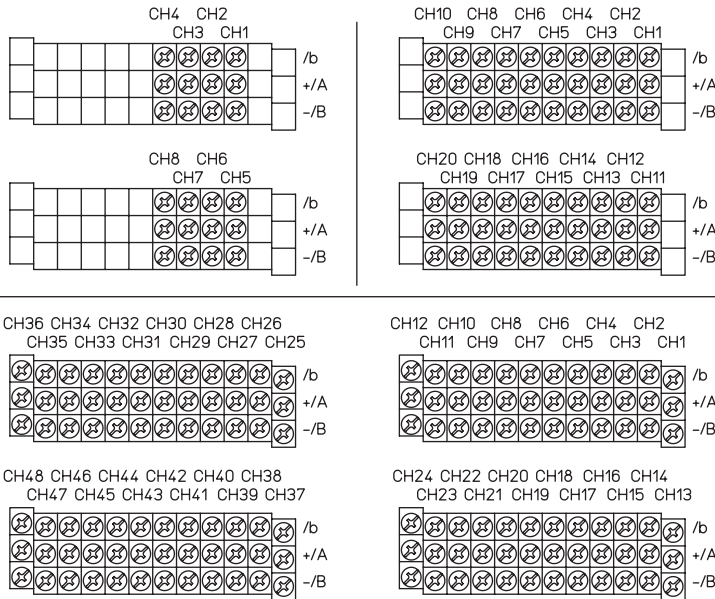

Clamped Terminals (/H2)

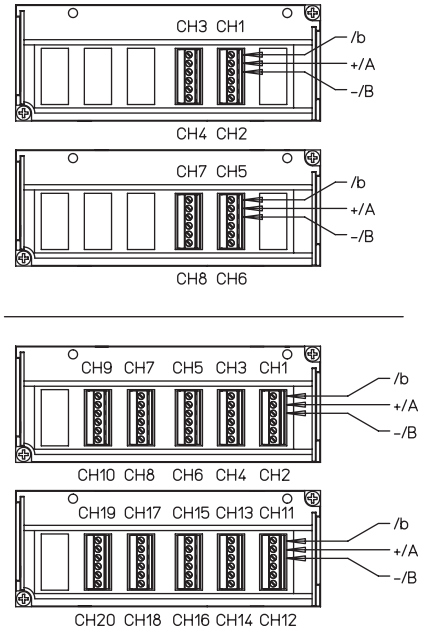

Option Terminals

/A1/F1/PM1 Combination

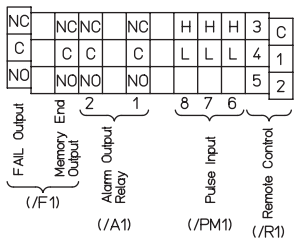

/A2/F1/R1 Combination

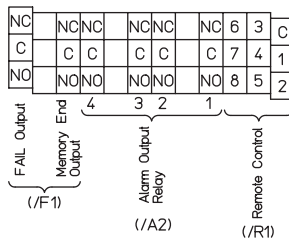

/A3/R1 Combination

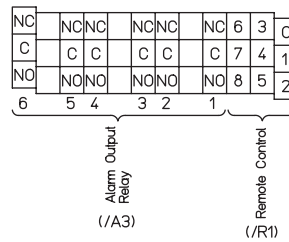

/A4/TPS4 Combination

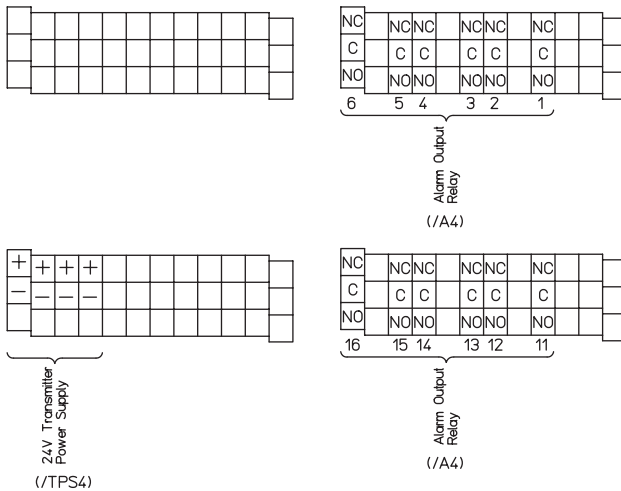

/A5/R1 Combination

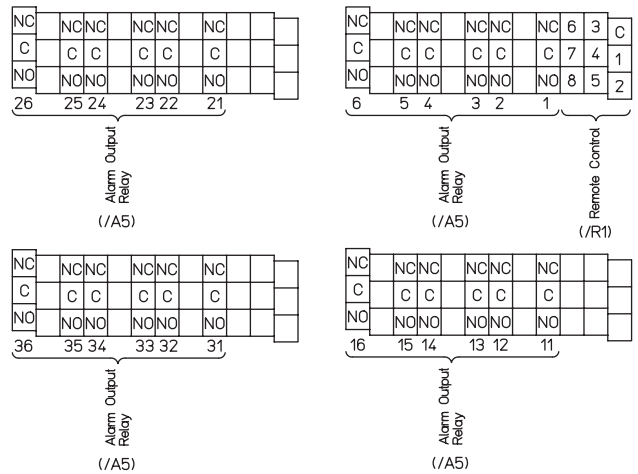

The TCP/IP software used in this product and the document for that TCP/IP software are based in part on BSD networking software, Release 1 licensed from The Regents of the University of California.

- DAQSTATION is a registered trademark of Yokogawa Electric Corporation.
- Microsoft, MS and Windows are registered trademarks of Microsoft Corporation USA.
- Lotus and 1-2-3 are registered trademark of Lotus Development Corporation.
- Pentium are registered trademarks of Intel Corporation.
- Ethernet is a registered trademark of XEROX Corporation.
- Modbus is a registered trademark of AEG Schneider.
- Other company and/or product names are registered trade mark of their manufactures.